

GRADE 5
Science
STAAR Alternate 2

Administered April 2016

RELEASED

SCIENCE

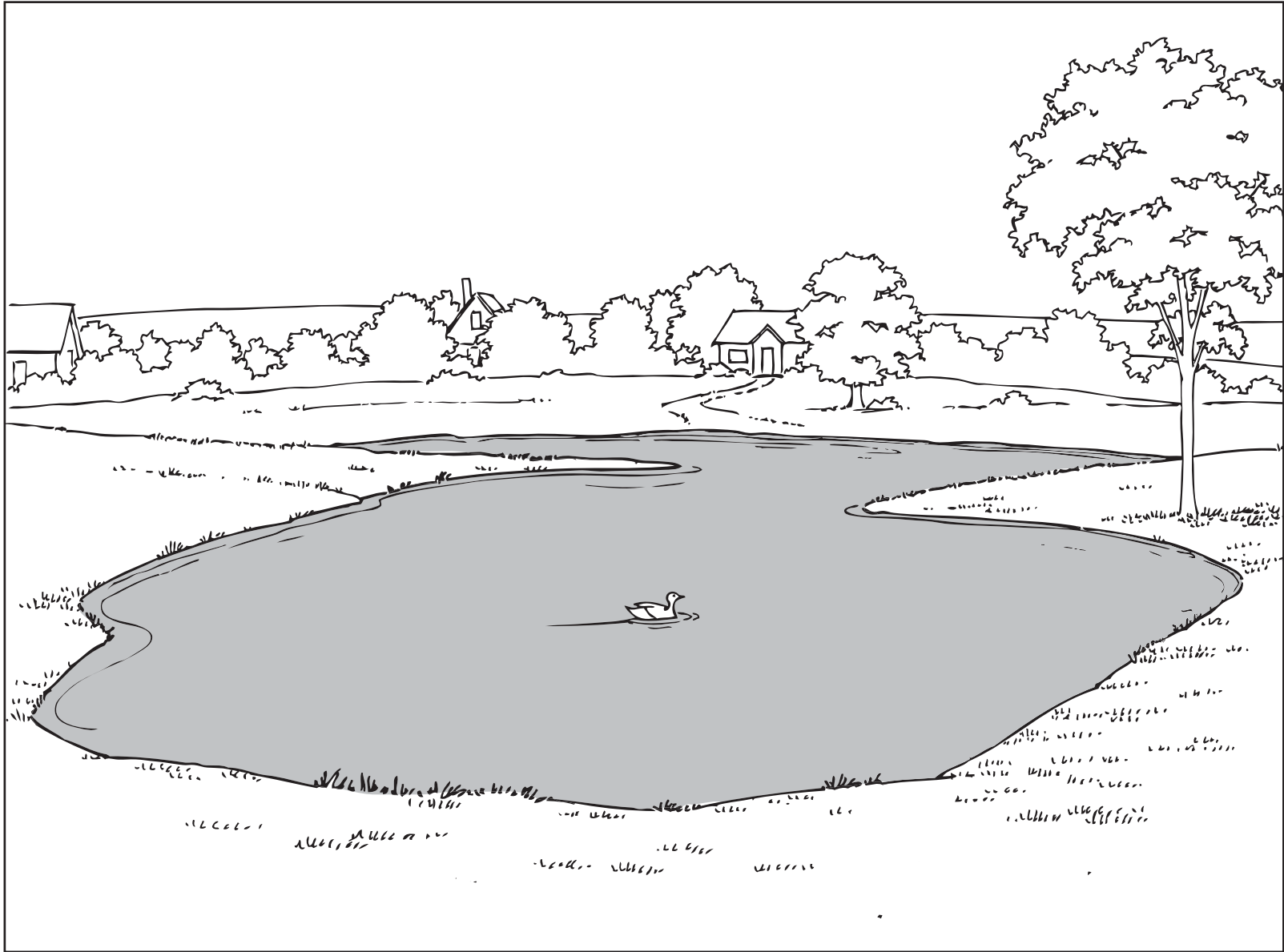

2a



2b



3a

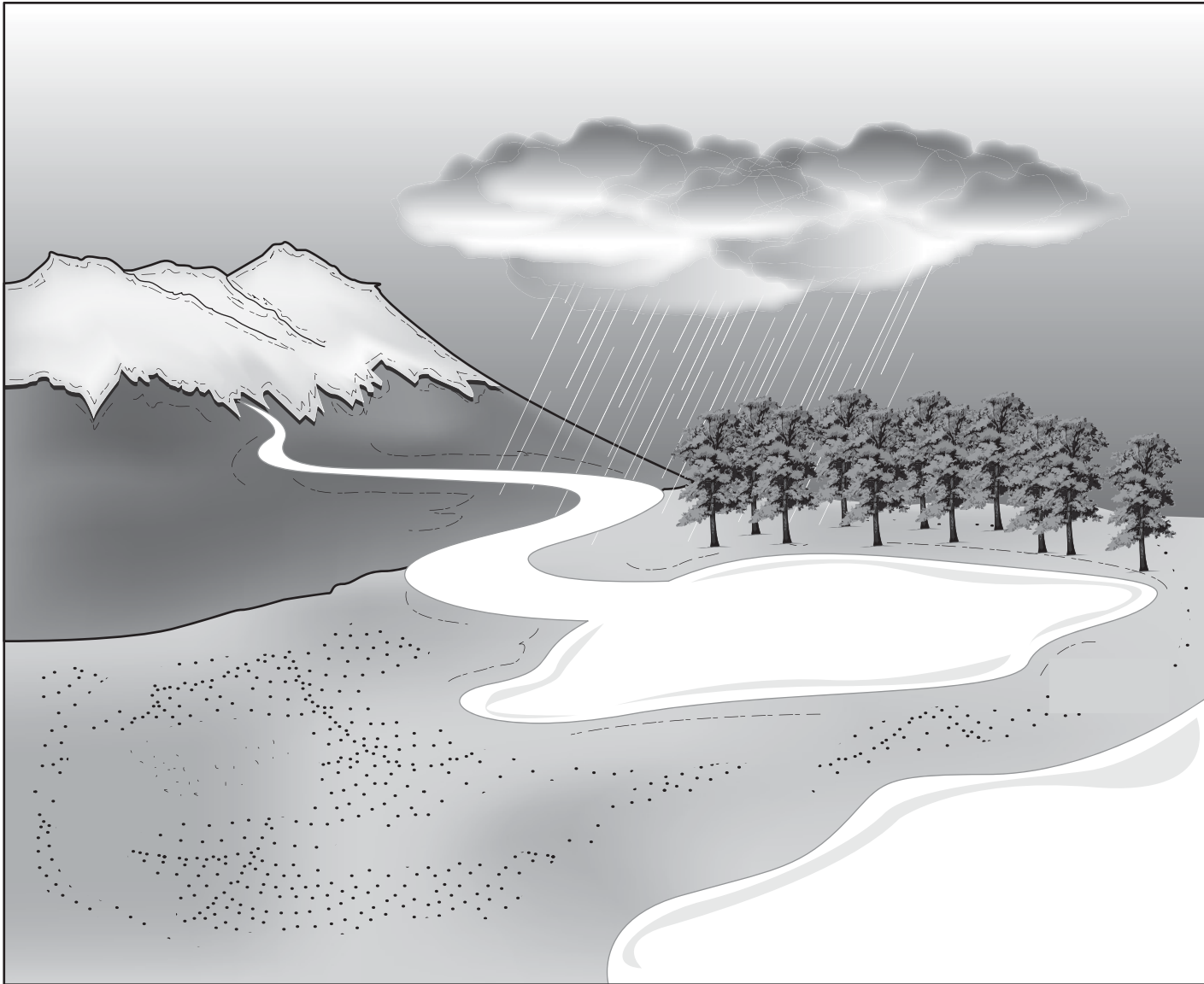

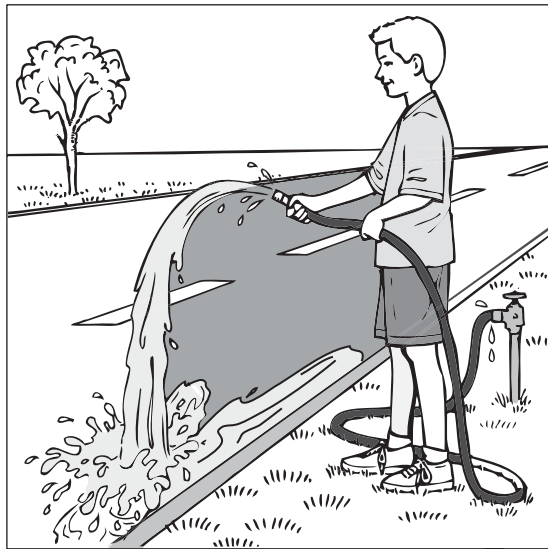

Four Ways to Conserve Water

- Use a broom instead of a water hose to clean sidewalks



- Collect rainwater to water plants



- Turn off water when not using it



-

Repair all water leaks as soon as possible



Wash a few clothes in a washing machine full of water



Water plants in pots until the pots are overflowing



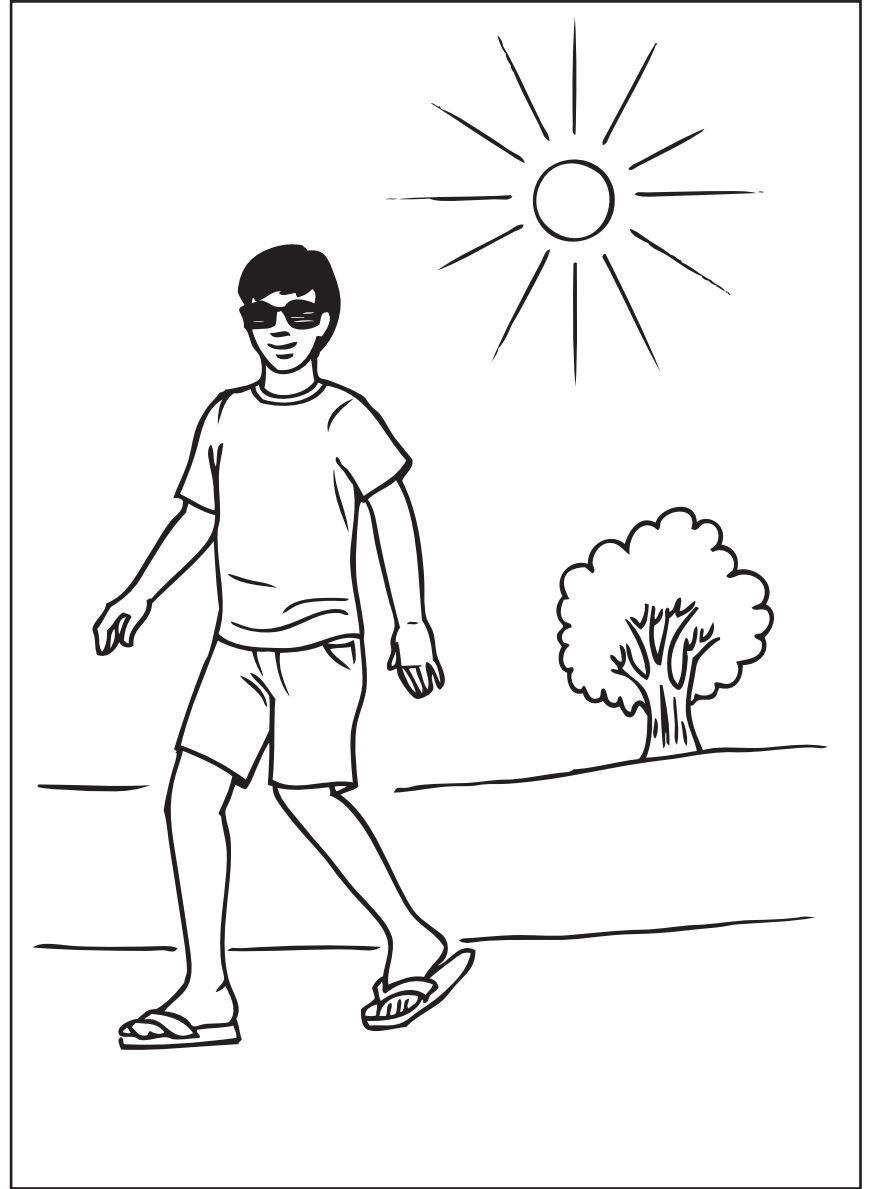

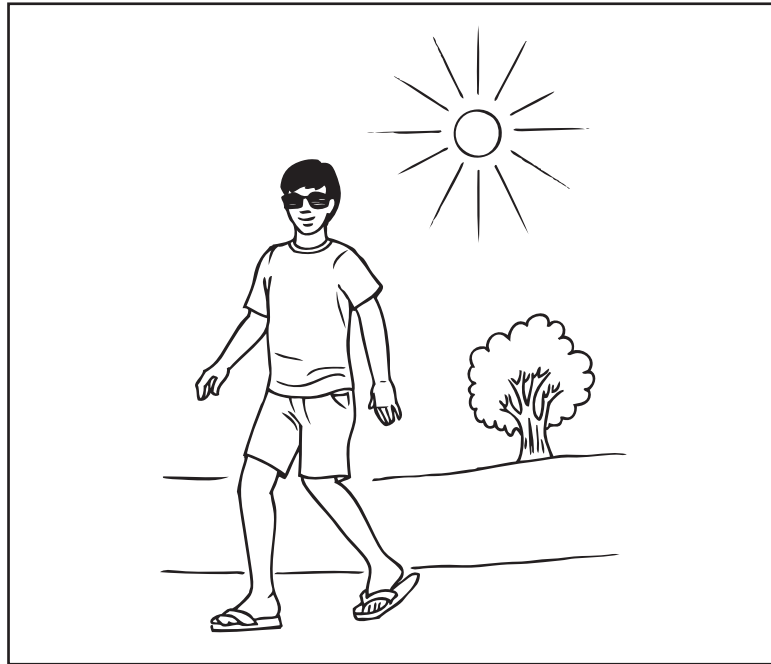

6a



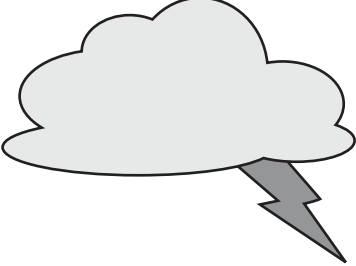

<u>Monday</u>	<u>Tuesday</u>	<u>Wednesday</u>
 <p>80% chance of rain Temperature 40°F</p>	 <p>90% chance of rain Temperature 45°F</p>	 <p>50% chance of rain Temperature 32°F</p>

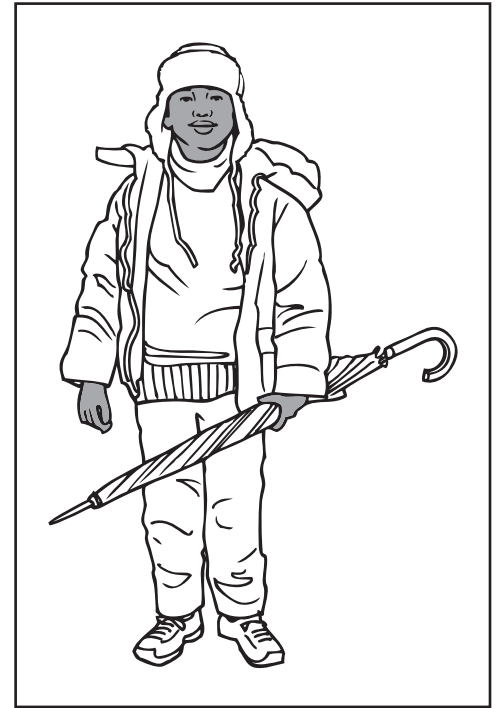

7b



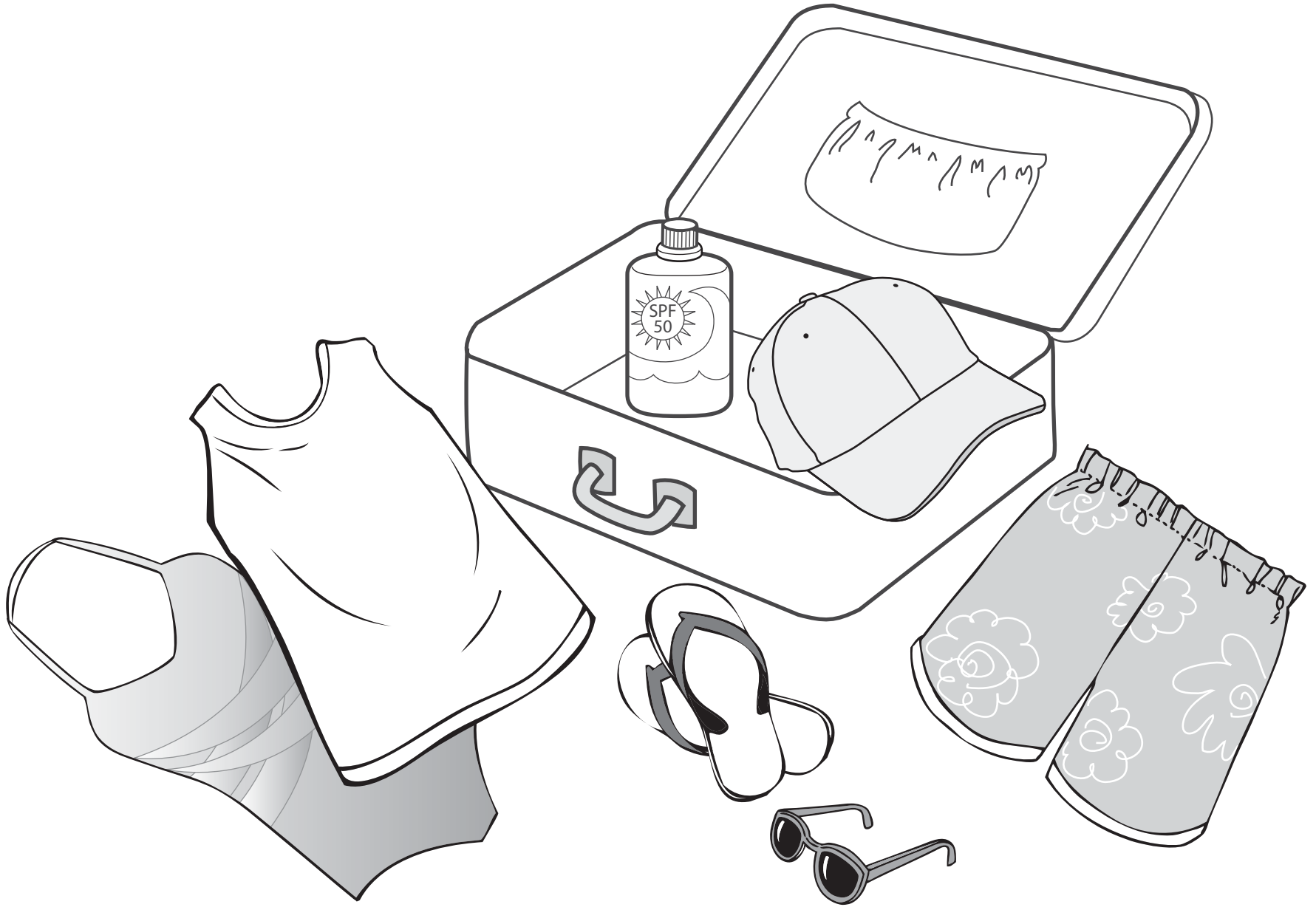

8a

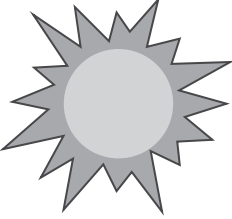

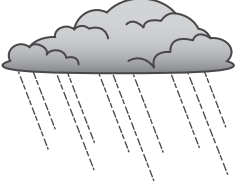
Oregon

July 1	July 2	July 3
		
Temperature 65°	Temperature 62°	Temperature 63°

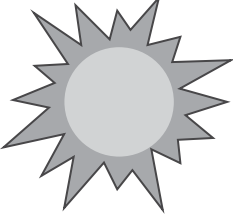
Florida

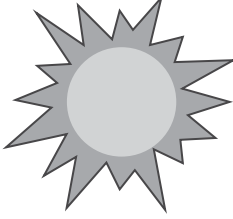
July 1	July 2	July 3
		
Temperature 93°	Temperature 90°	Temperature 95°

Alaska

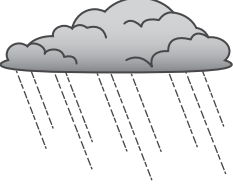
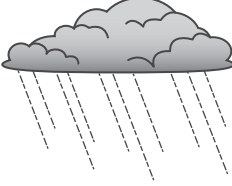
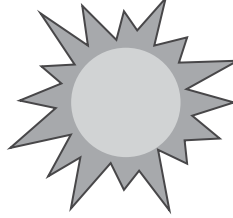
July 1	July 2	July 3
		
Temperature 50°	Temperature 49°	Temperature 51°



10a



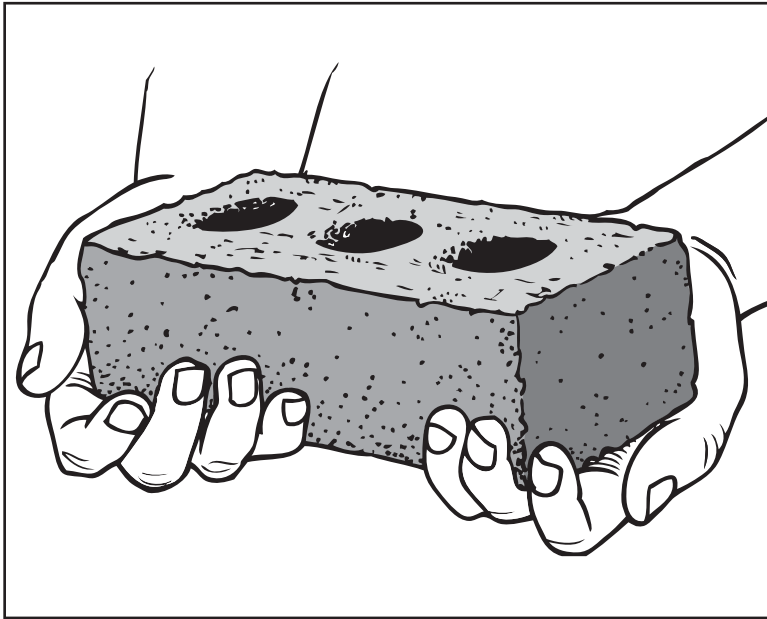

11a

wood
blocks

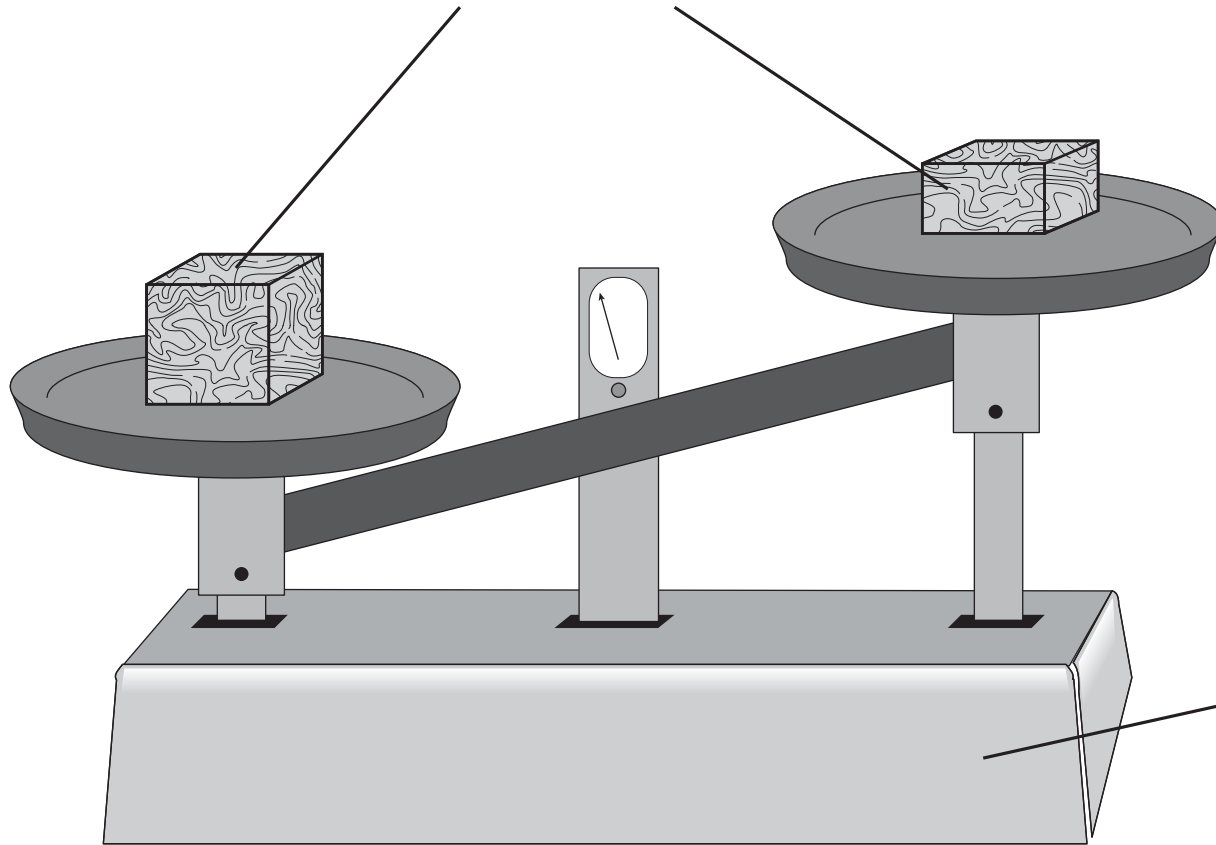

balance

mass

temperature

color

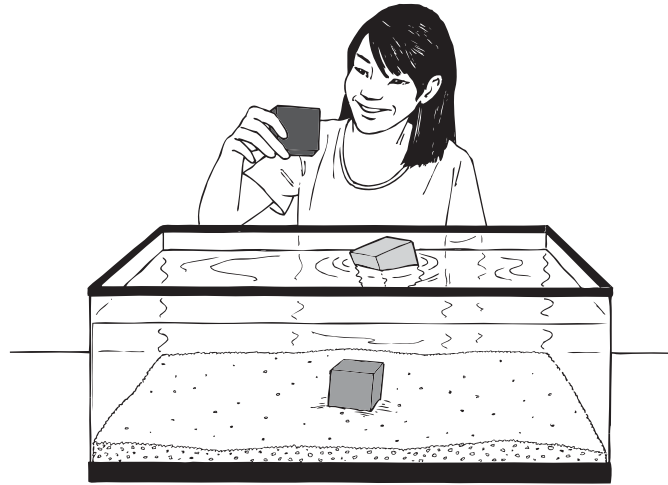

Material	Dissolves in Water?	Floats on Water?
A	Yes	No
B	No	Yes
C	No	No

12b

A

B

C

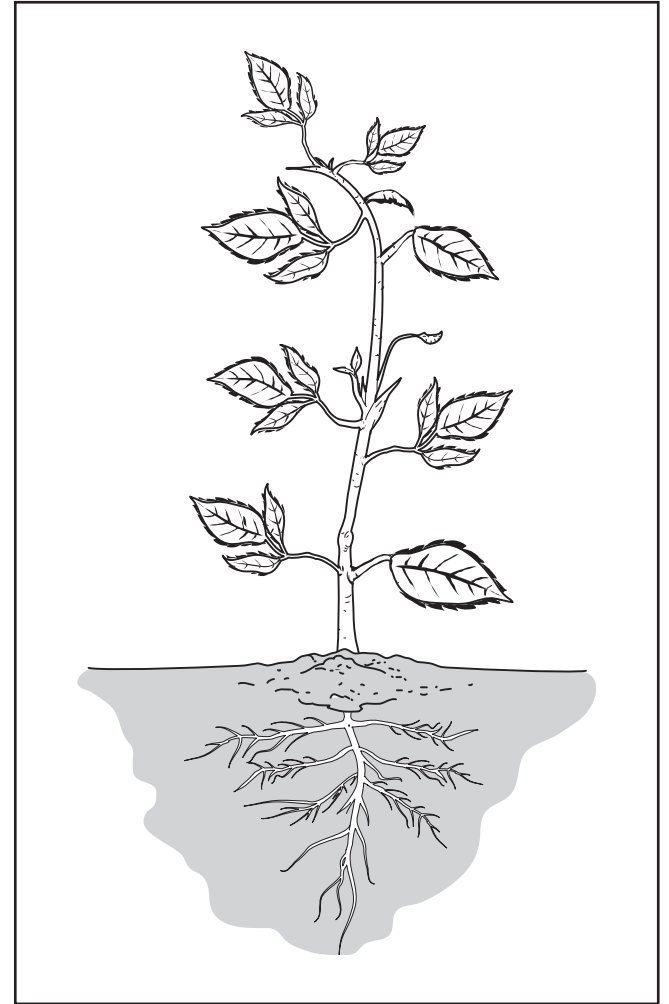
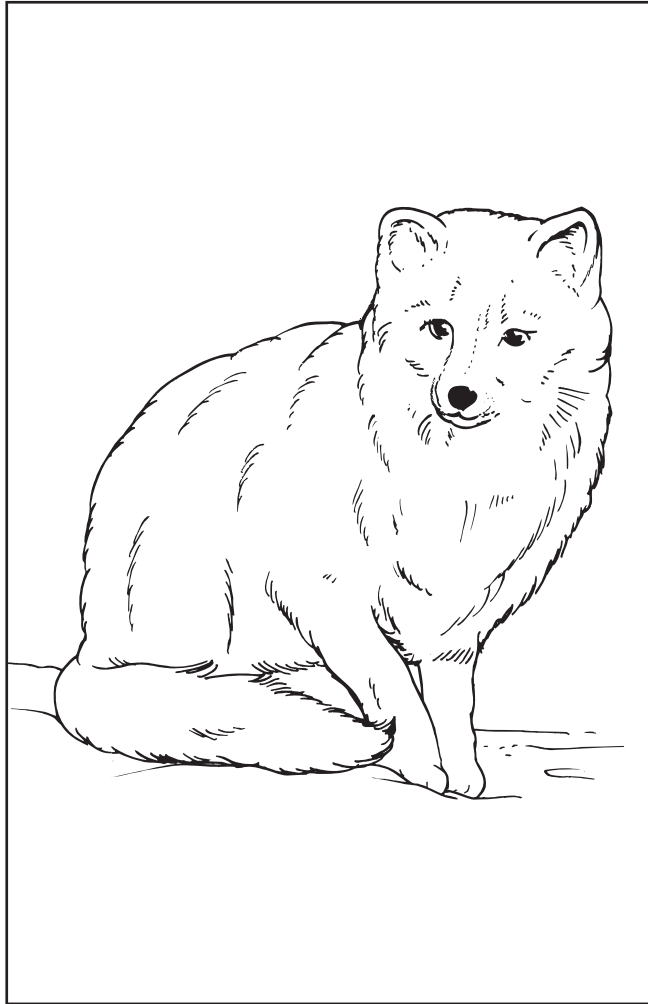

14a

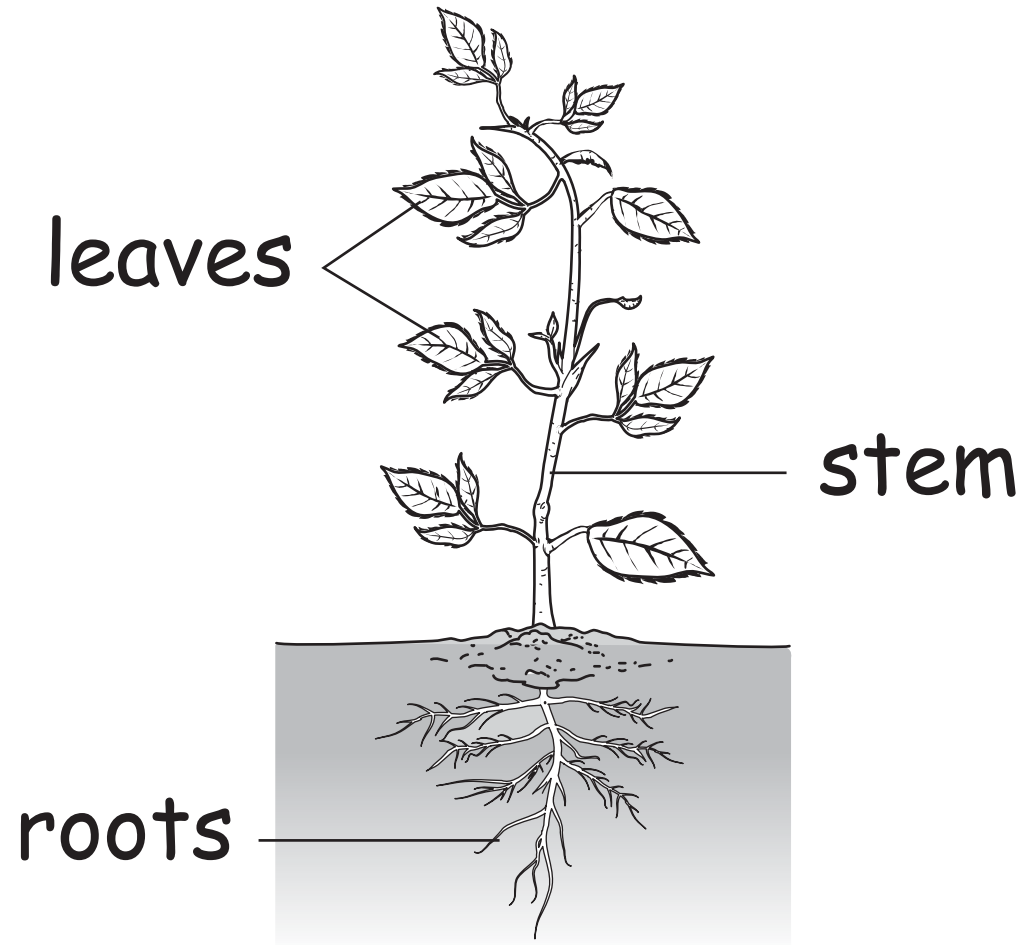

14b

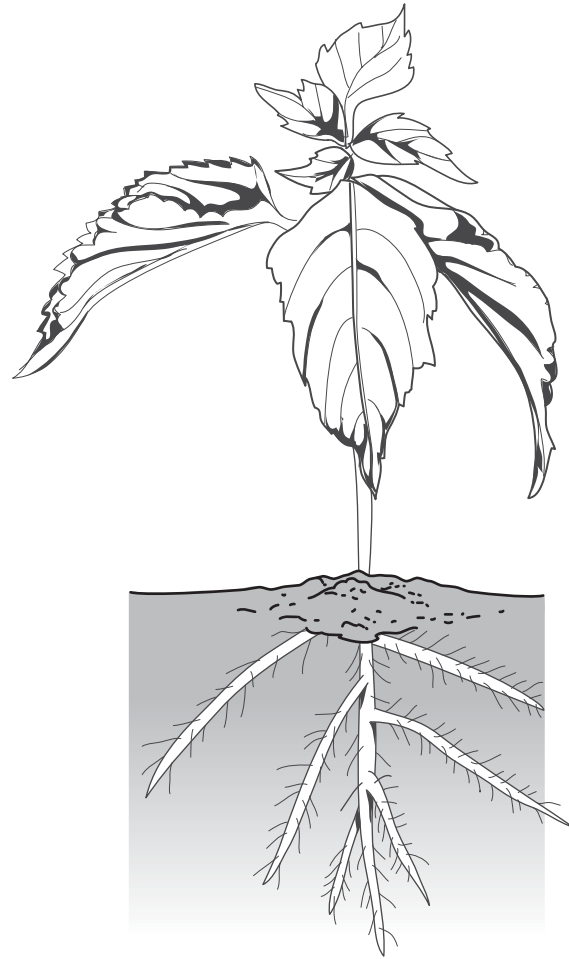

15a

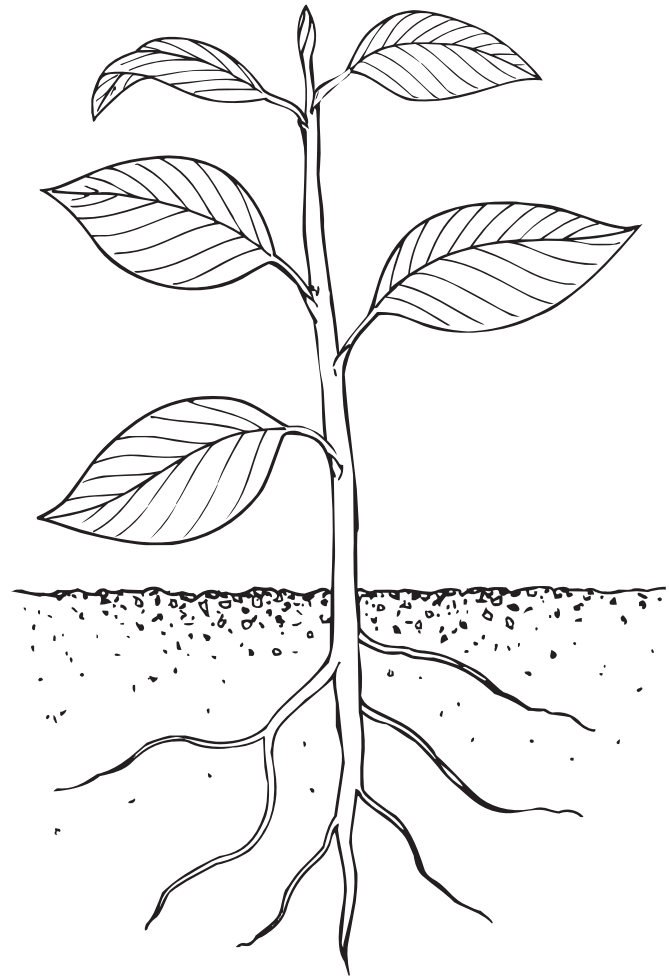
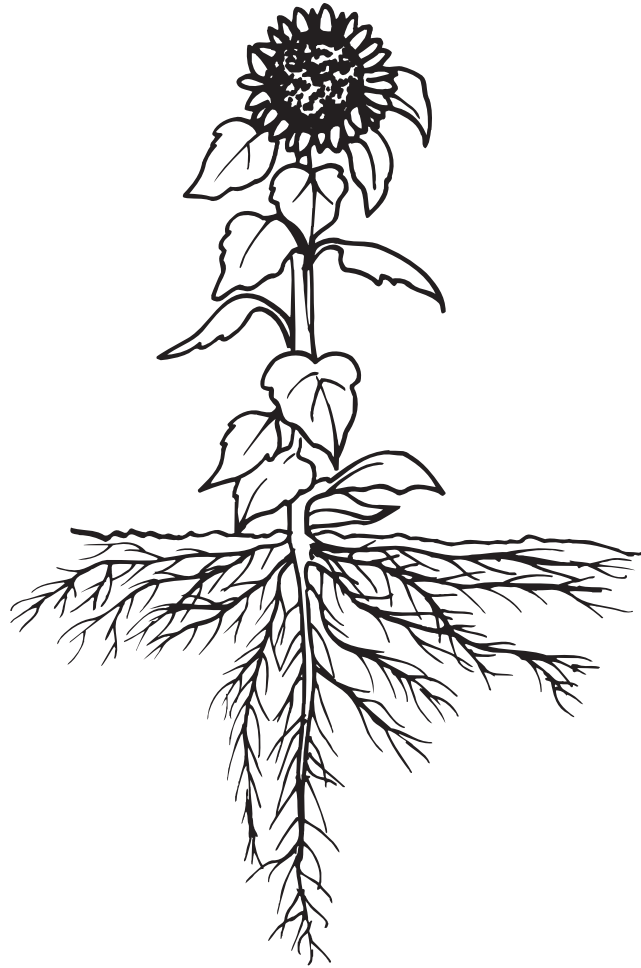

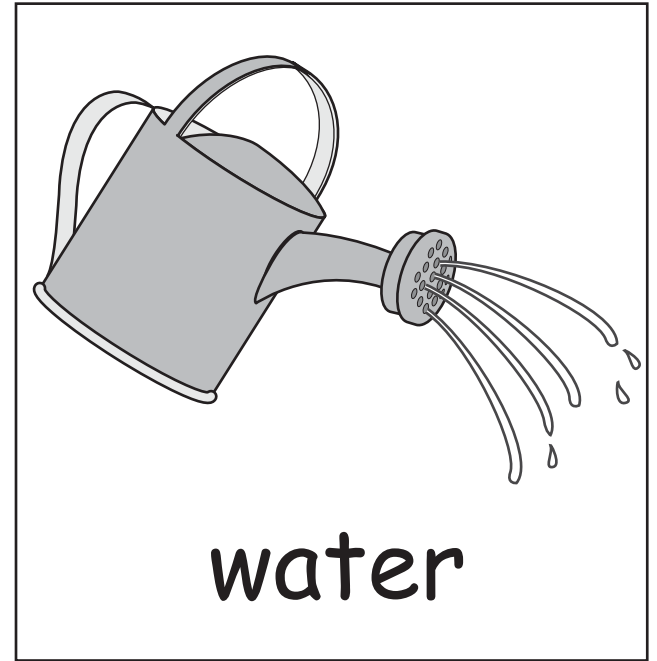
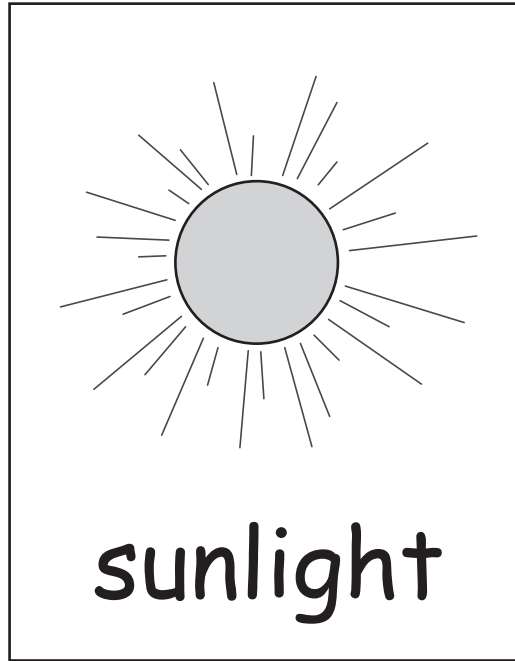

16a

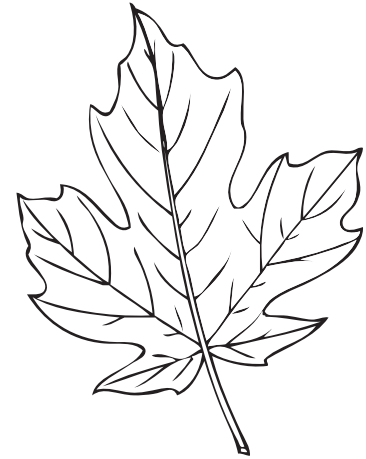
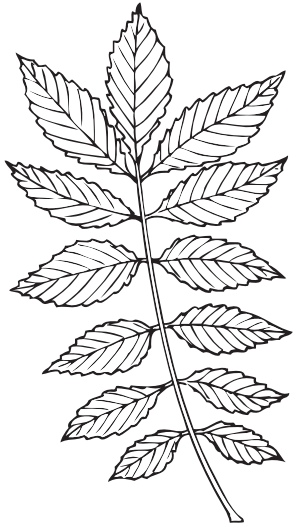

Leaves collect and use sunlight.

Leaves hold the plant in the ground.

Leaves are the same size and shape.



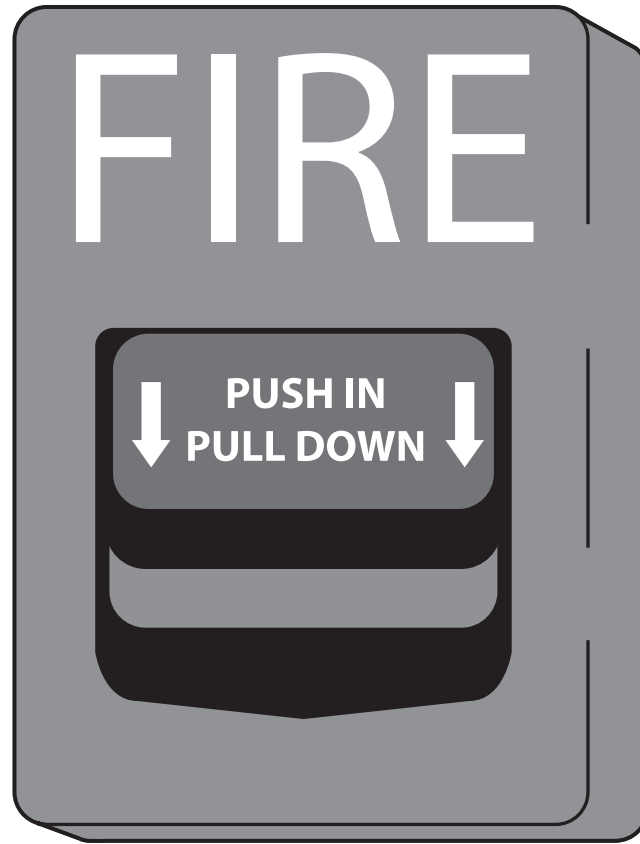

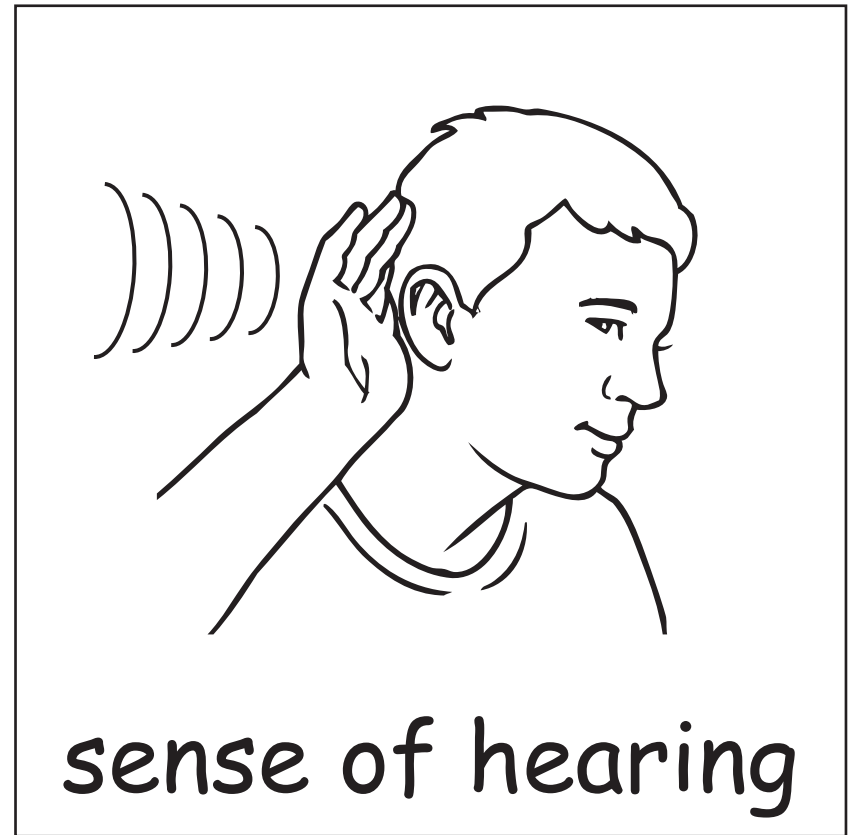
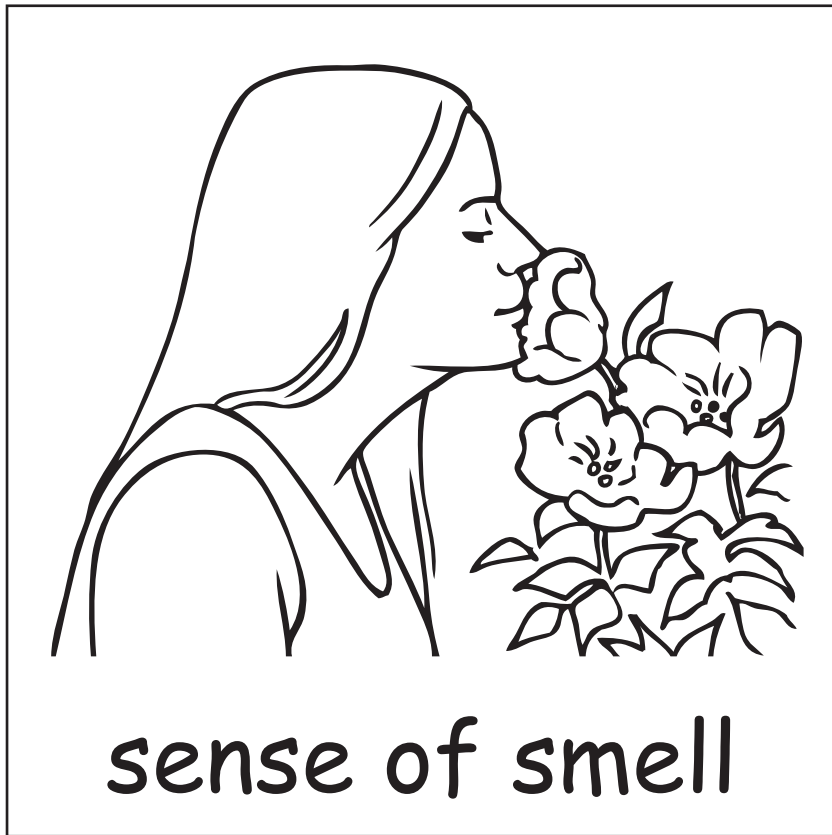

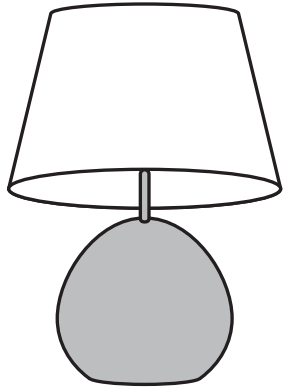

lamp

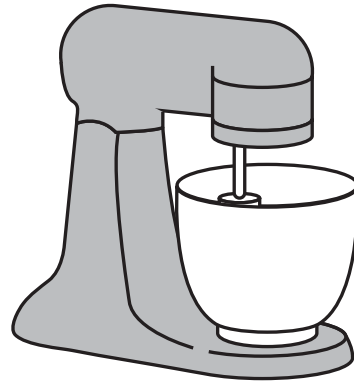

mixer

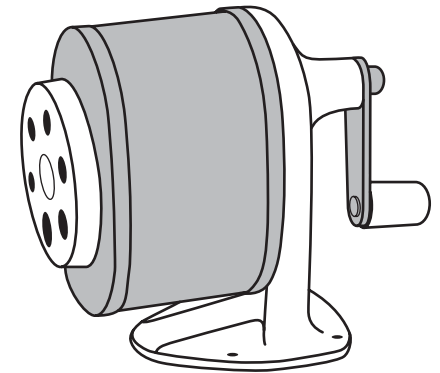

pencil
sharpener

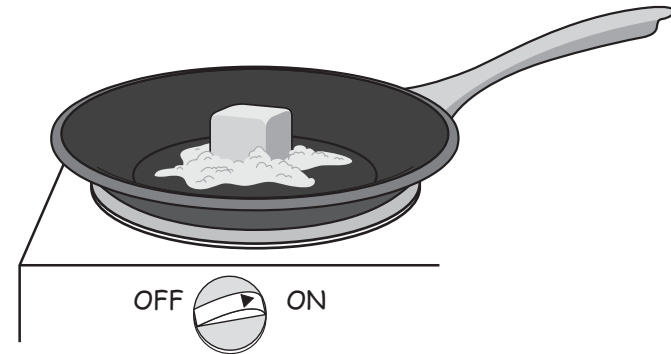
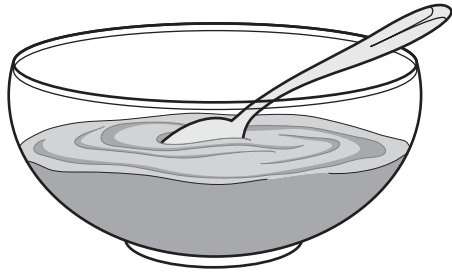

stir the ingredients and melt
the butter

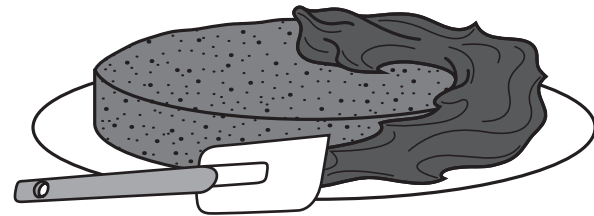

bake the cake and spread the
frosting

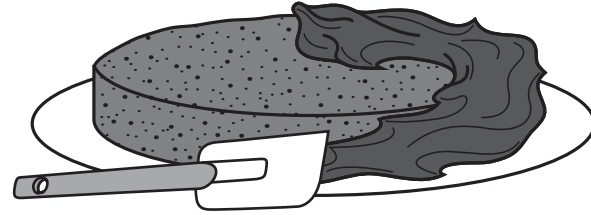
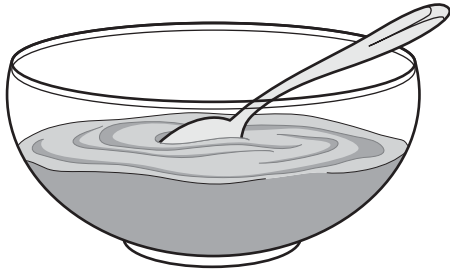

stir the ingredients and spread
the frosting

**STAAR ALTERNATE 2
GRADE 5
Science
April 2016**